

ٲراڊري اڪر هان ڦوتو



ٲراڊري ٻولي مان ڀڻيا نو ڪتاب

ٿراڌري هان سنڌي مانئي الف بي نا آواز

| سنڌي | ٿراڌري | سنڌي | ٿراڌري | سنڌي | ٿراڌري | سنڌي | ٿراڌري |
|------|--------|------|--------|------|--------|------|--------|
| پ | پ | پ | پ | ب | ب | ا | ا |
| ٺ | ٺ | ٺ | ٺ | ٺ | ٺ | ت | ت |
| ڄ | ڄ | ج | ج | پ | پ | ٺ | - |
| ڇ | ڇ | چ | چ | ج | ج | جھ | جھ |
| ڌ | ڌ | د | - | خ | - | ح | - |
| ڙ | - | ڍ | ڍ | ڊ | - | ڌ | ڌ |
| س | س | ز | ز | ڙ | ڙ | ر | ر |
| ٺ | - | ض | - | ص | - | ش | ش |
| ف | - | غ | - | ع | - | ظ | - |
| ڪ | ڪ | ڪا | ڪا | ق | - | قا | قا |
| ڱ | - | گھ | گھ | ڳ | ڳ | گ | گ |
| ٺ | ٺ | ن | ن | م | م | ل | ل |
| ي | ي | ء | ء | ھ | ھ | و | و |

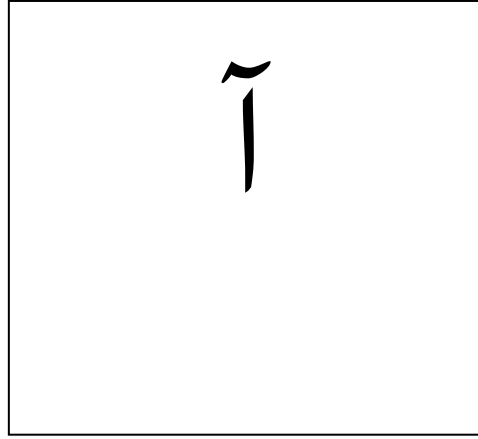
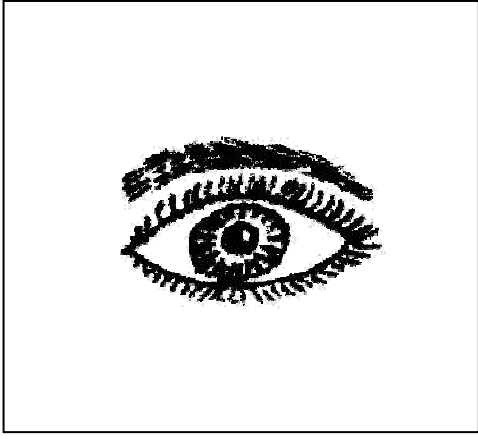

آنچ

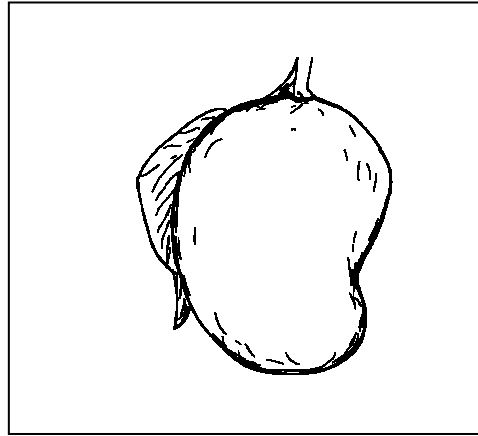
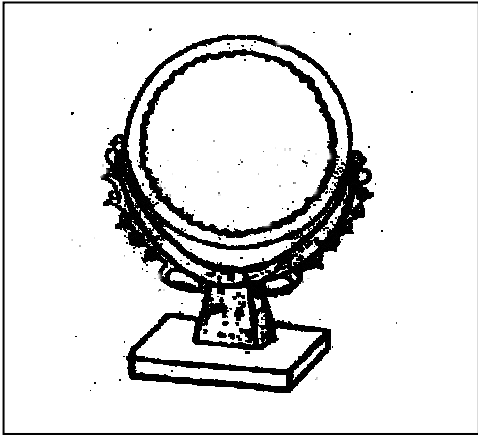

آرشي

آنپڑي

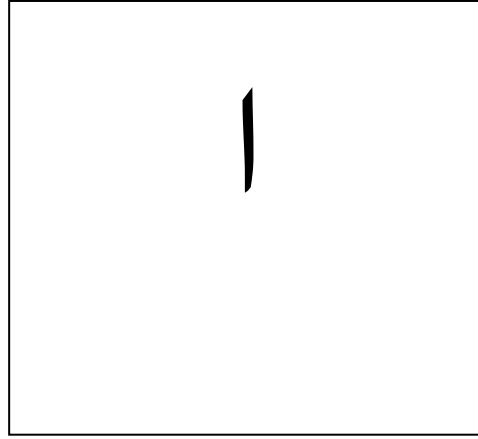
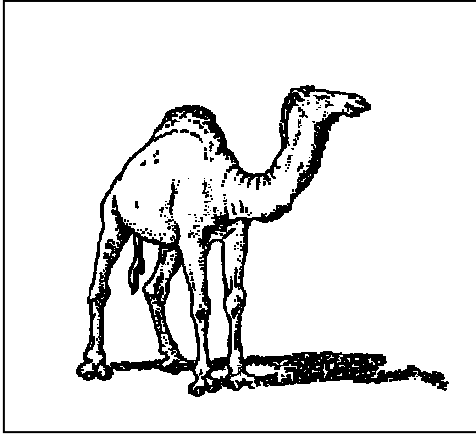

أونٹ

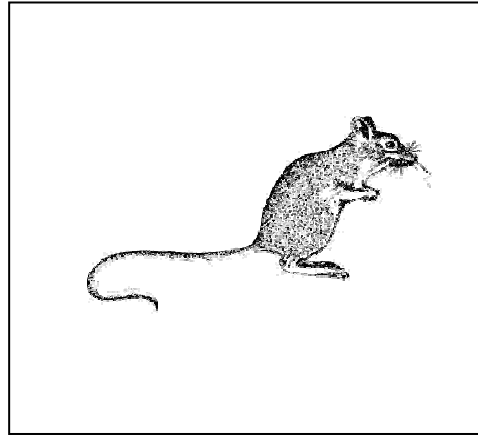
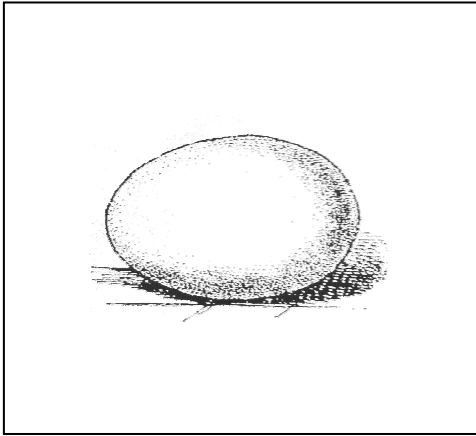

اینڈون

اوندیٹرو

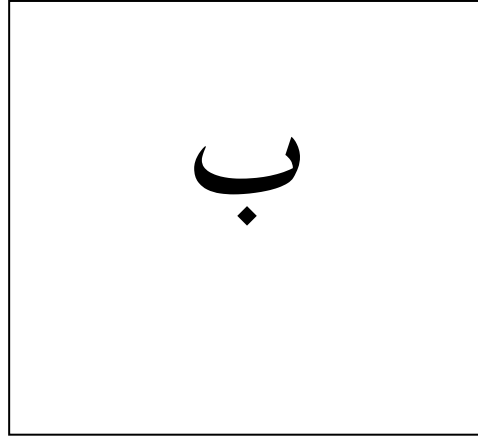
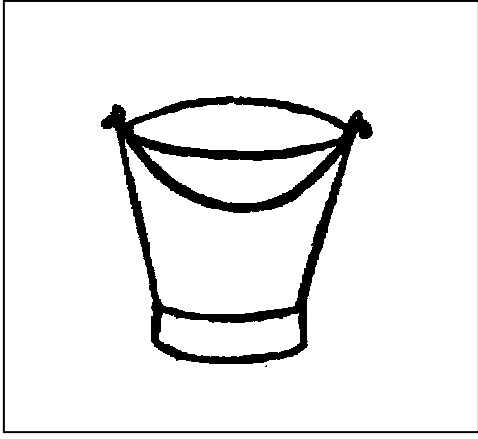

بالتّي

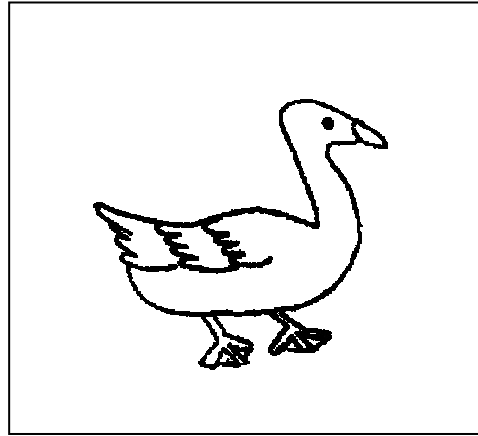
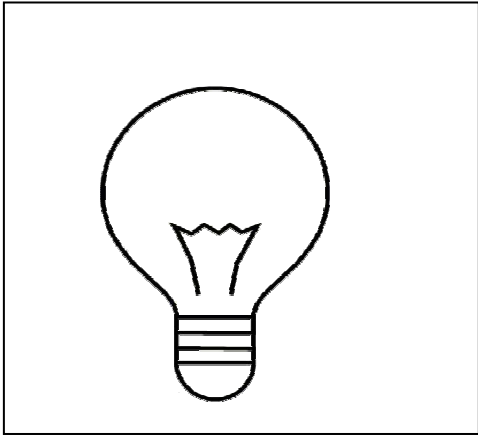

بِلقِ

بَدِكِ

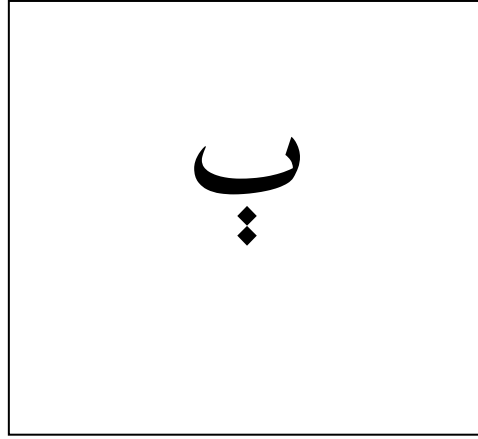
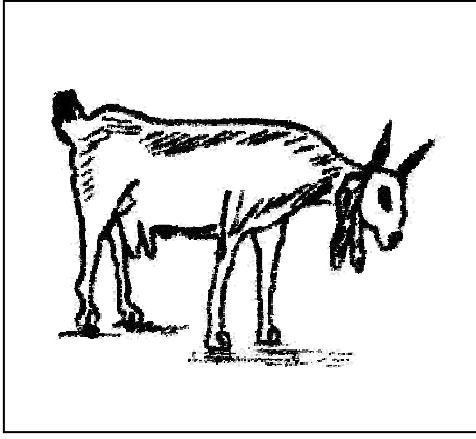

پکری

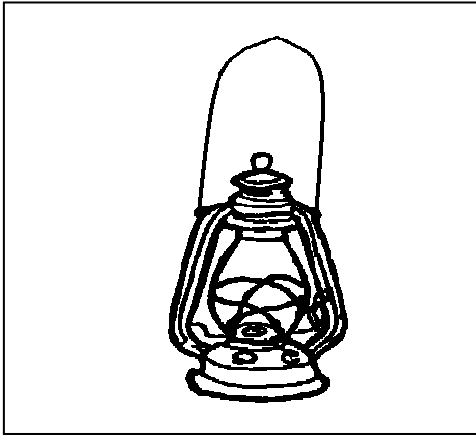

پتی

پائیڑی

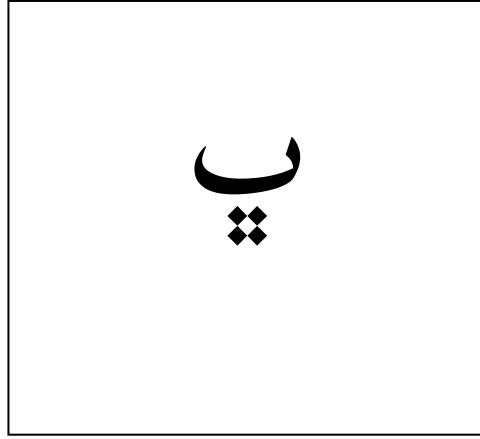
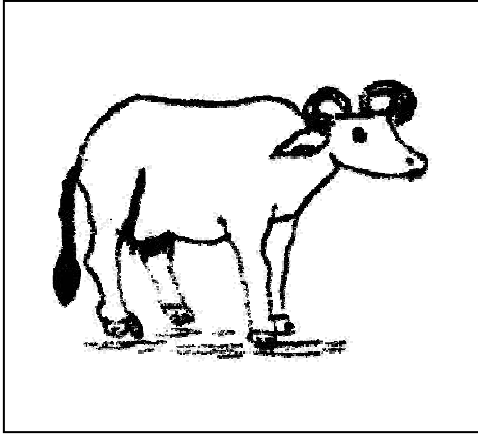

پینش

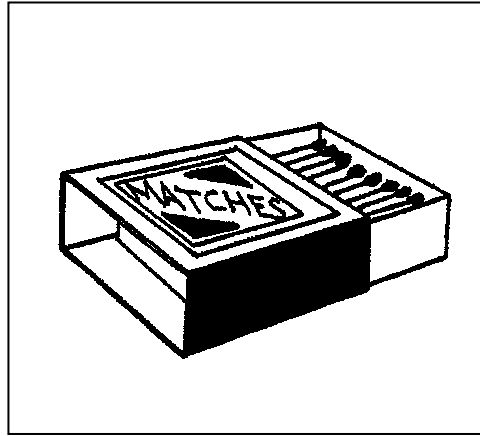
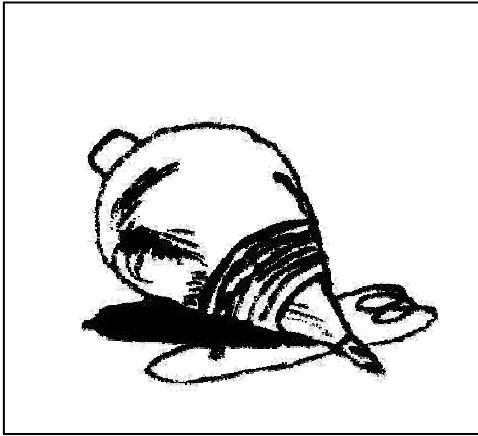

پمیزو

پاکش

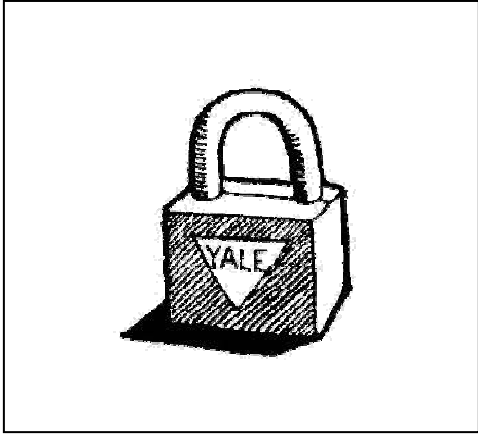

ت

تارُون

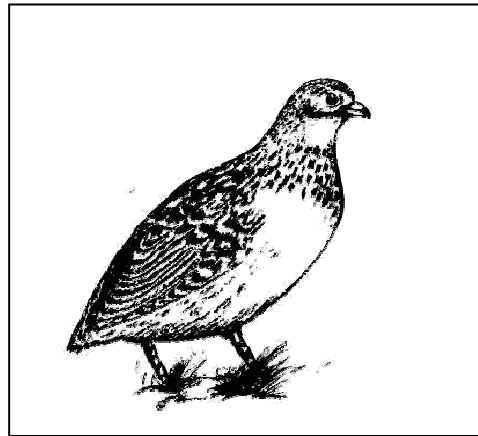
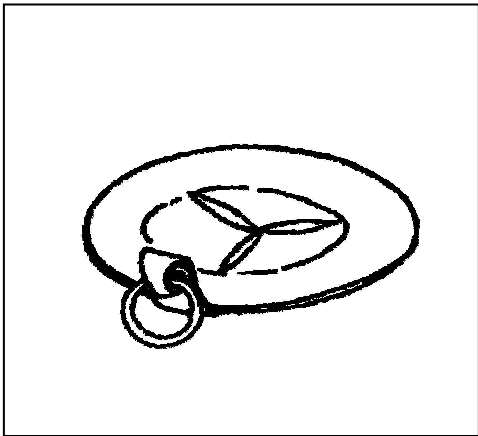

توڑِي

تِيتر

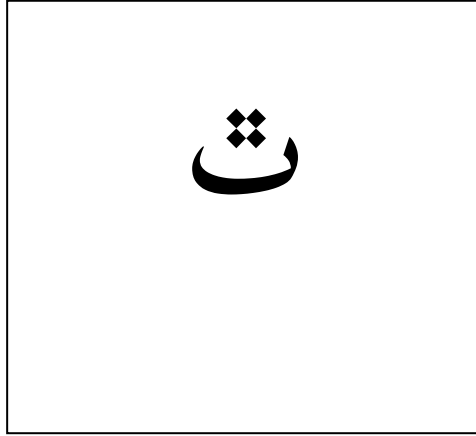
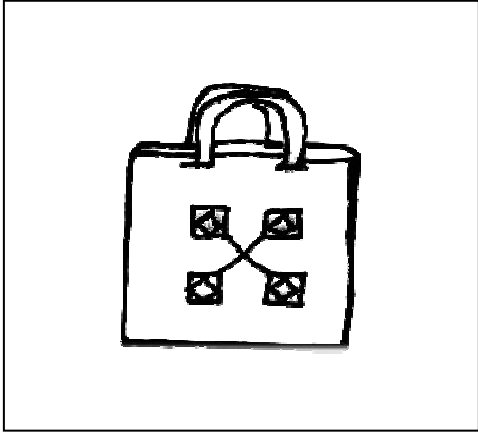

ٲٲلو

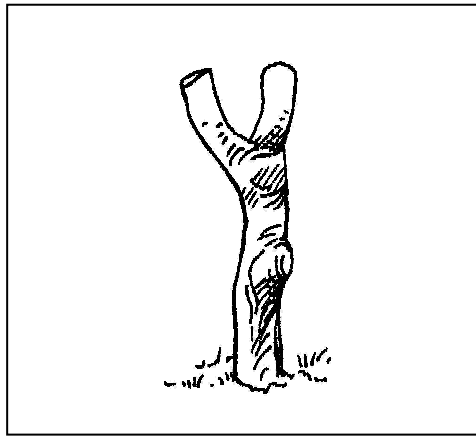
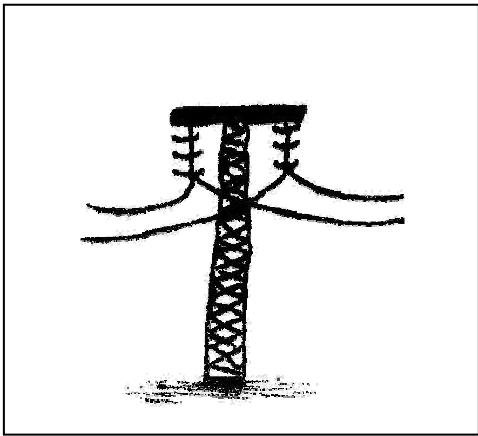

ٲٲٲ

ٲٲٲٲٲ

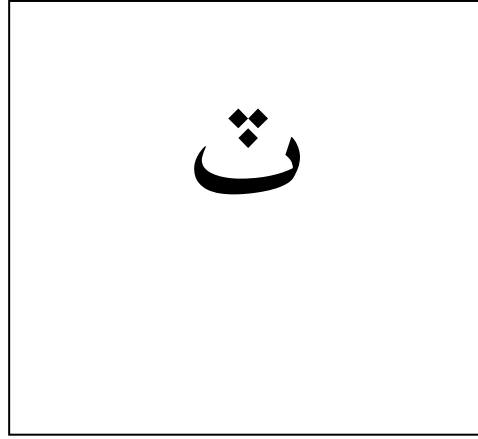
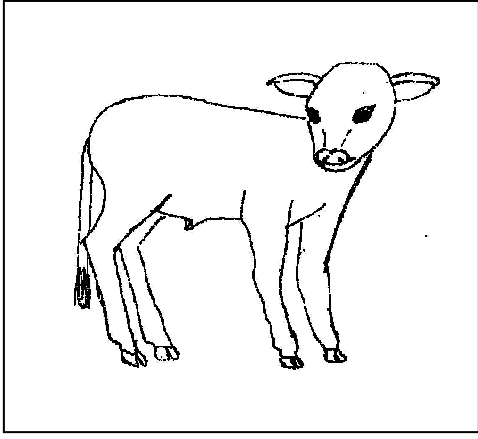

توگھڑو

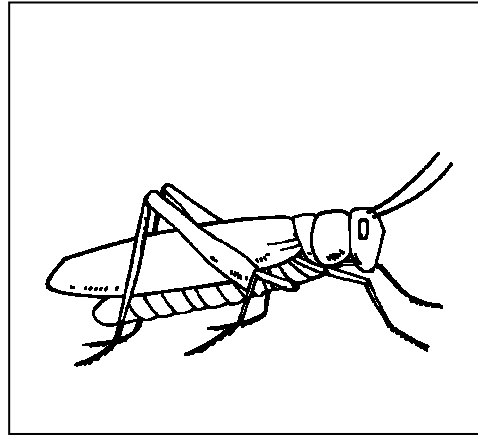

تانگھو

تید

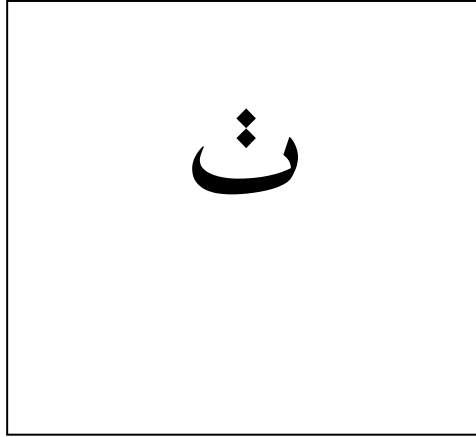
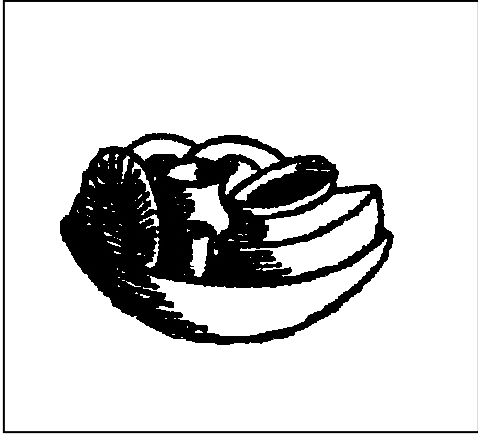

ٹانپڑان

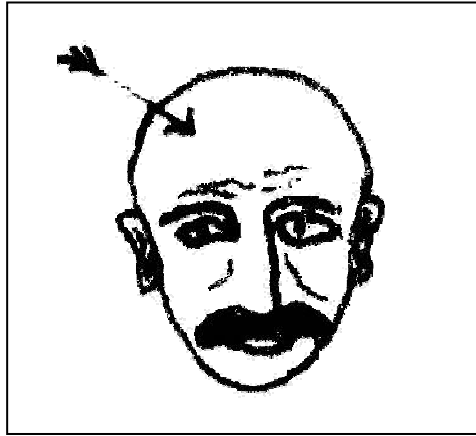
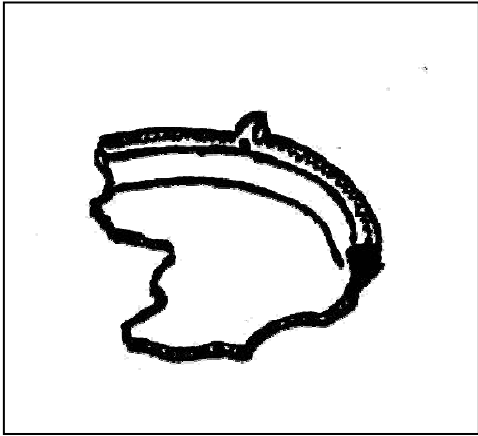

ٹیپرون

ٹوڑھو

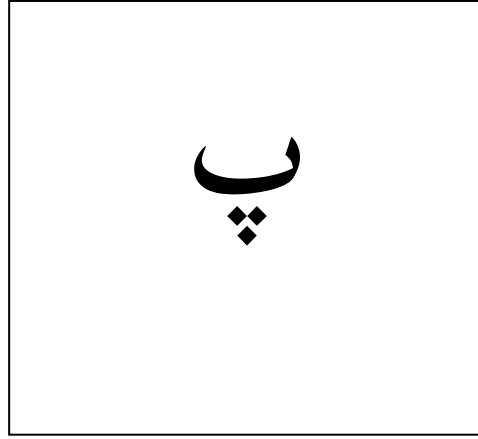
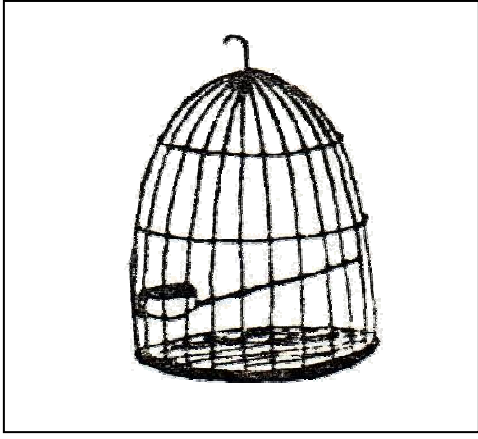

پینزرون

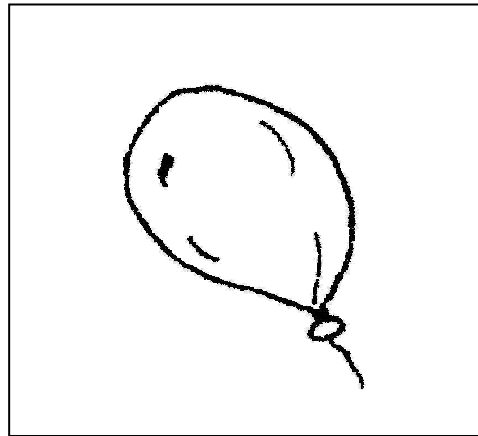
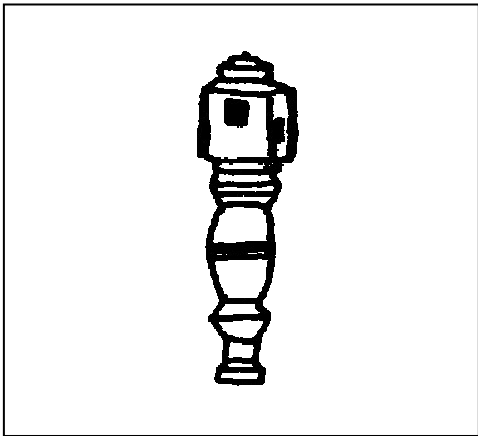

پایو

پوپتو

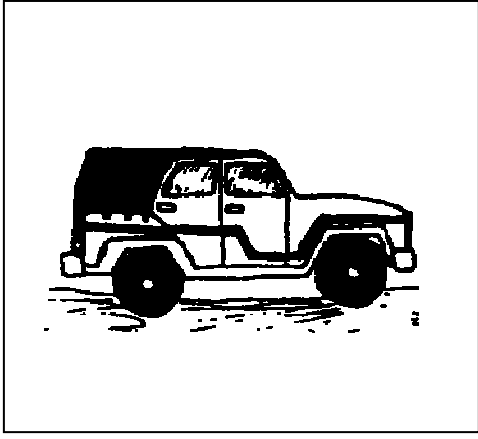

ج

چپ

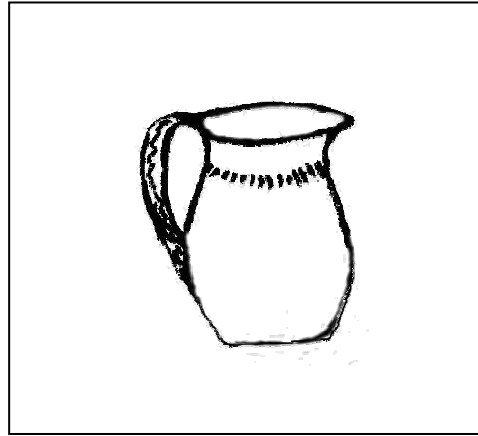
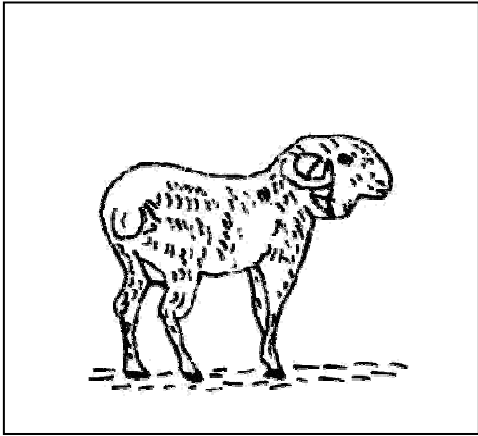

جیتو

جڳ

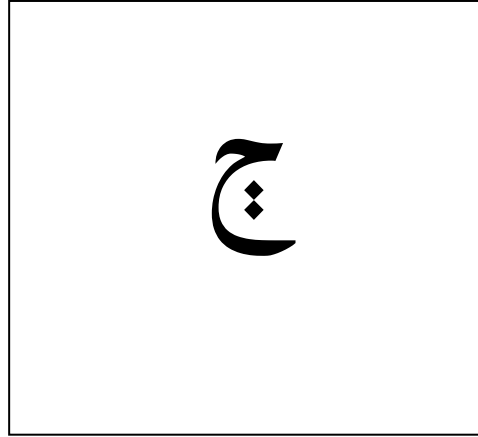
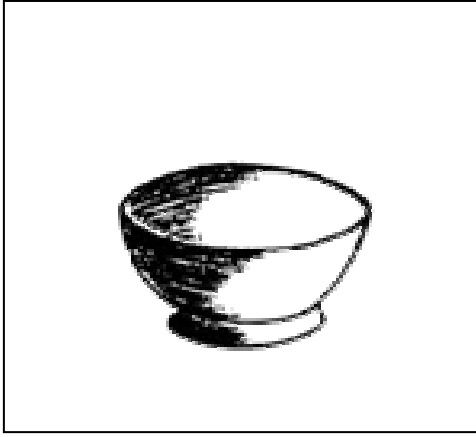

چمنون

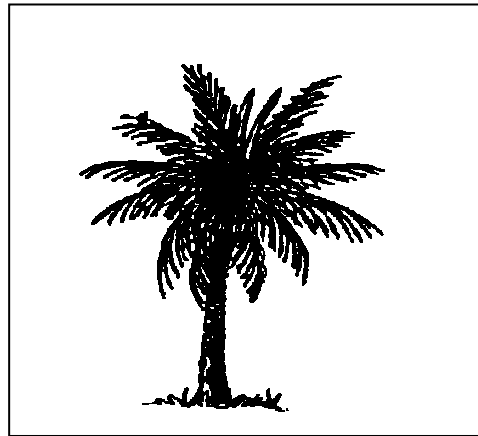
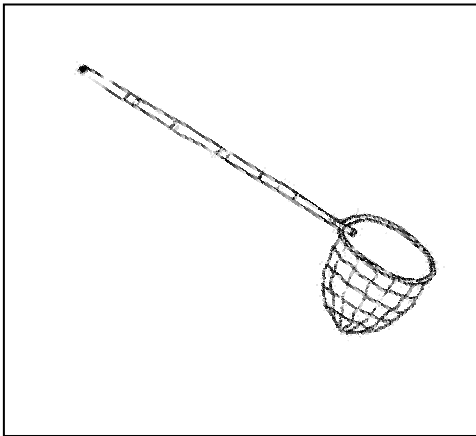

چاري

کچي

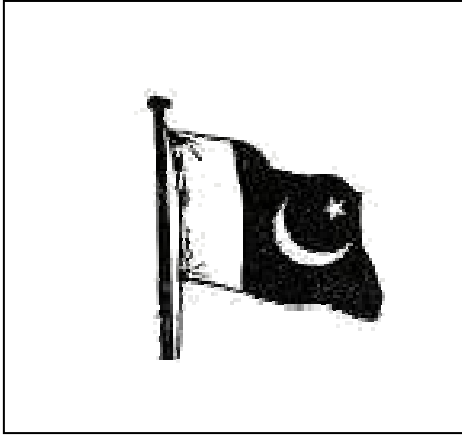

جہ

جہندیو

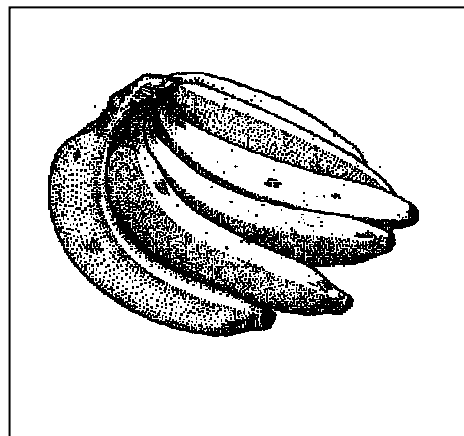
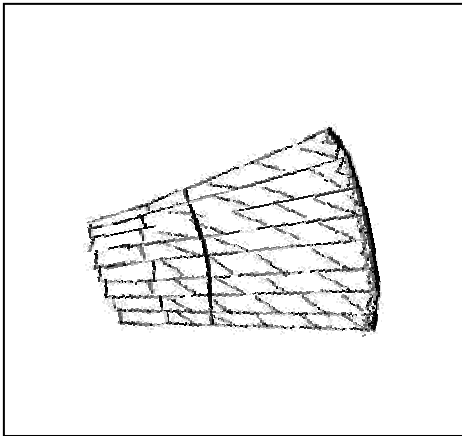

جھوڑی

جھوڑو

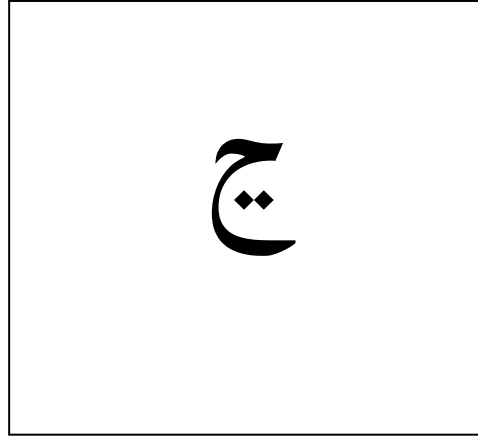
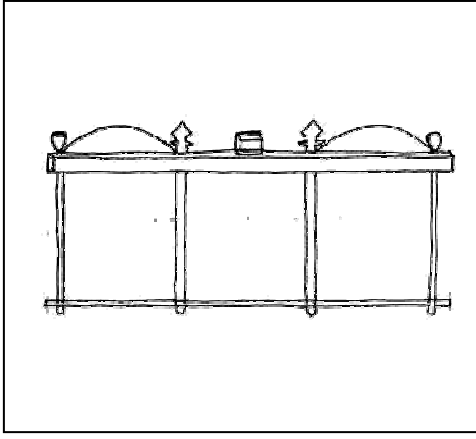

پنجاري

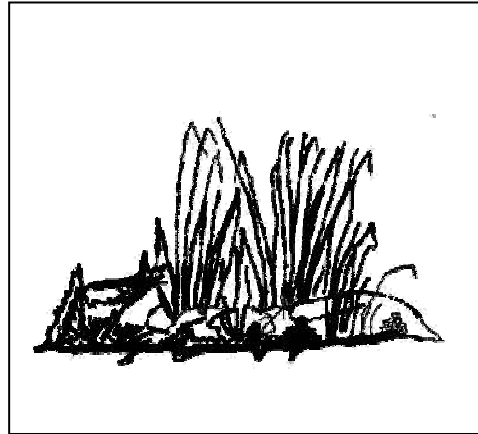
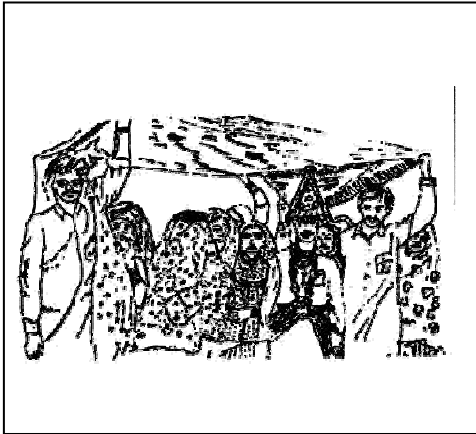

زانچ

پنج

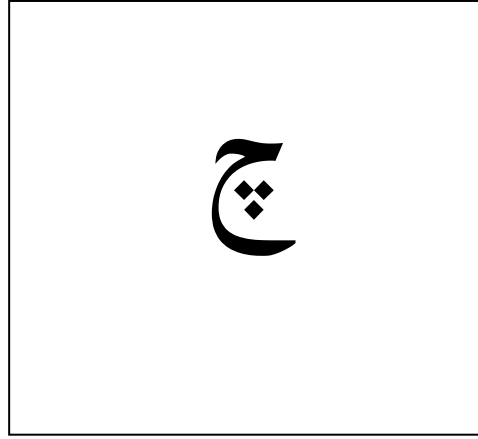
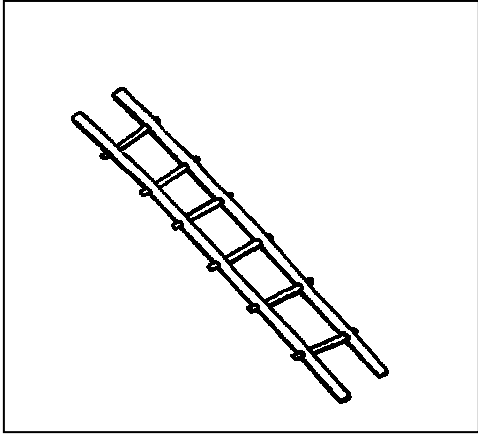

چاڑِي



چمچو

چولو

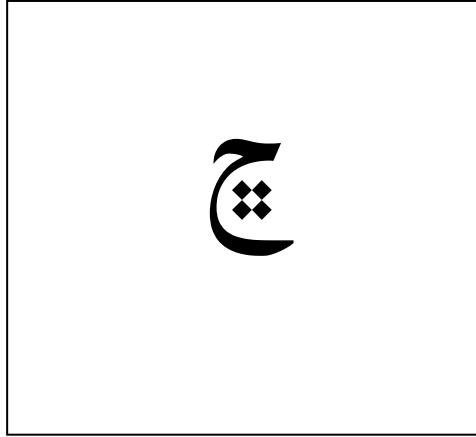
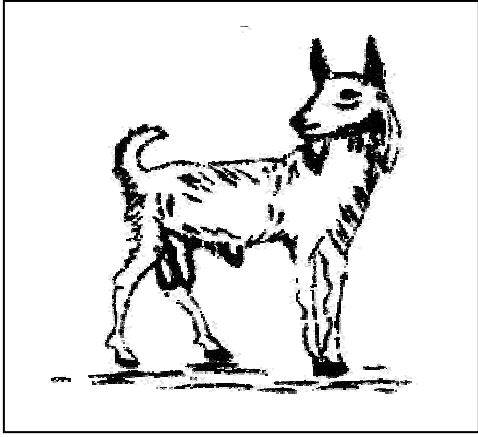

چیلو

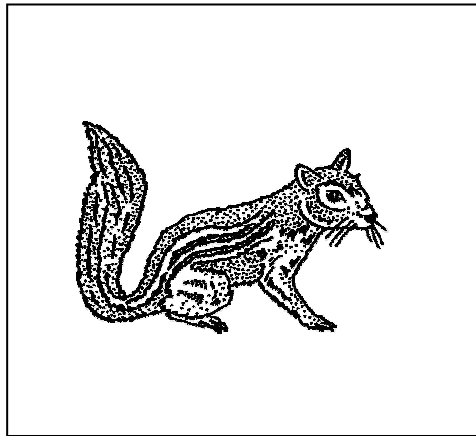
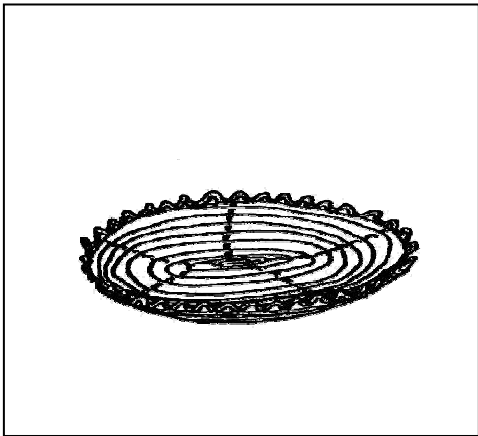

چپی

چلکوڑی

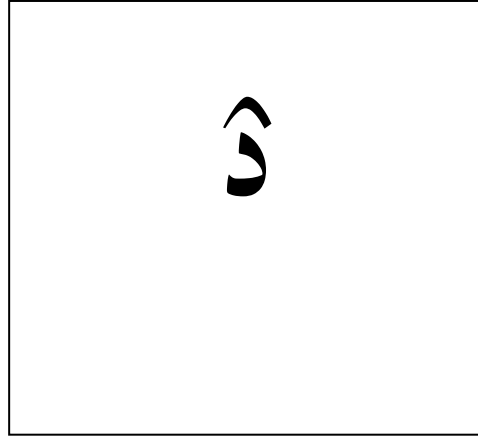
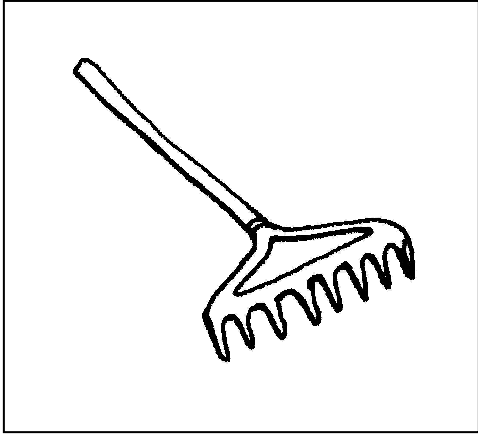

ڏندار

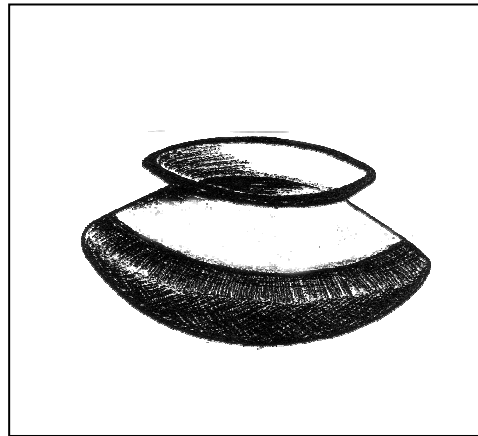
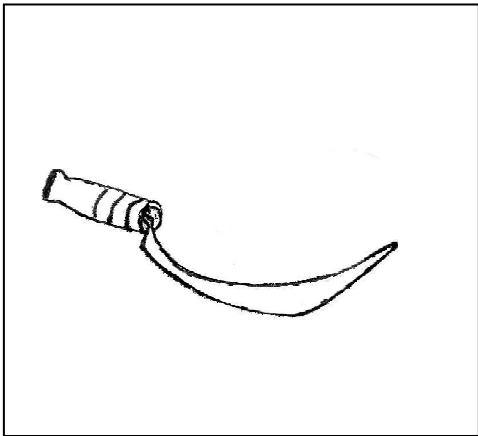

ڏاتيرُون

ڏيڳ

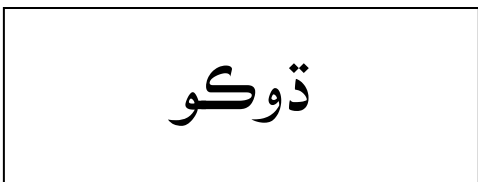
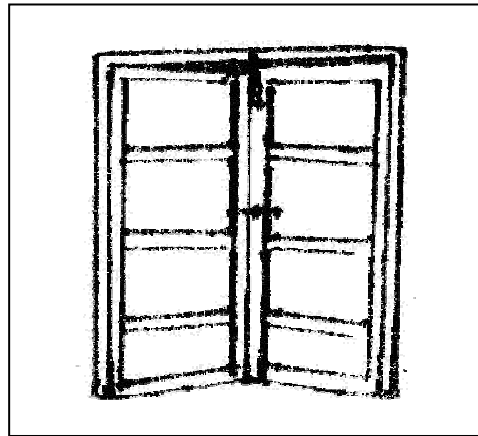
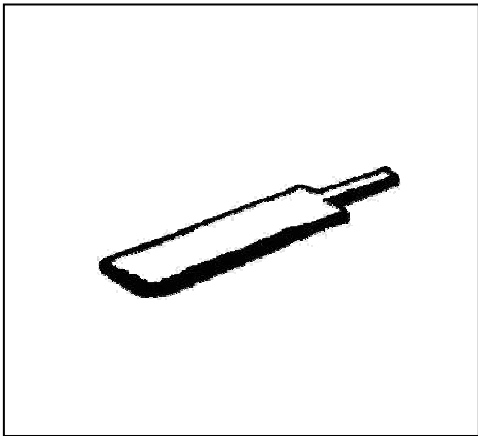
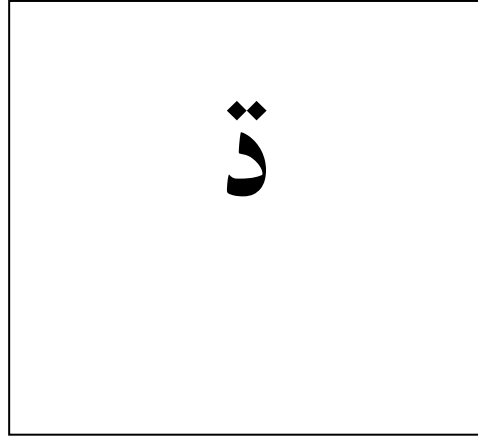
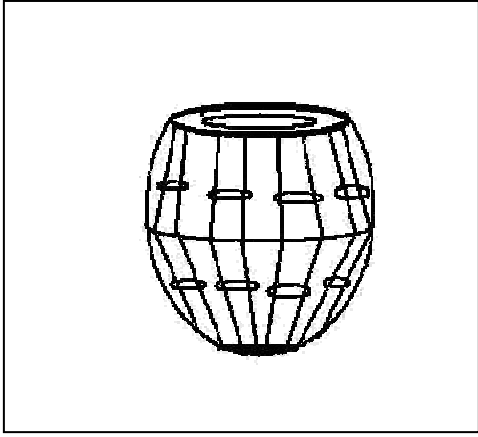

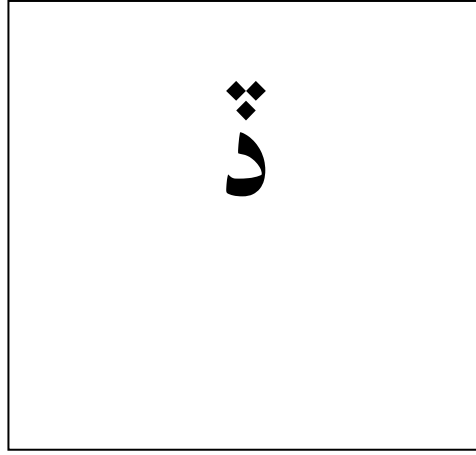
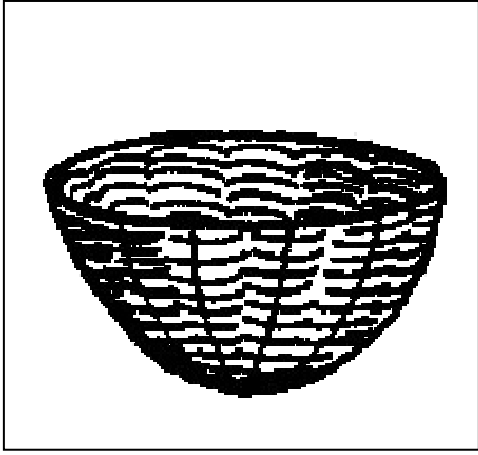

ذَلُو

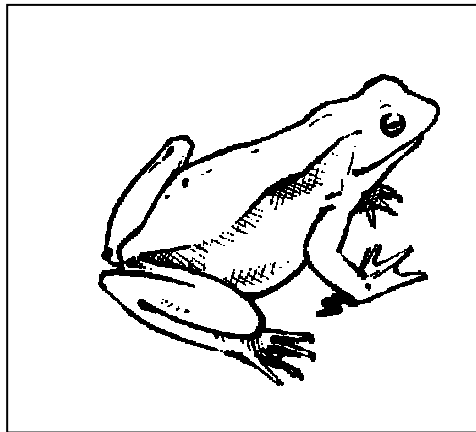
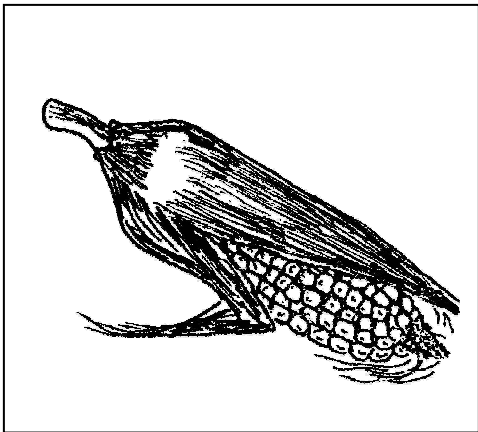

ذَوْدُو

ذَيْدُكُون

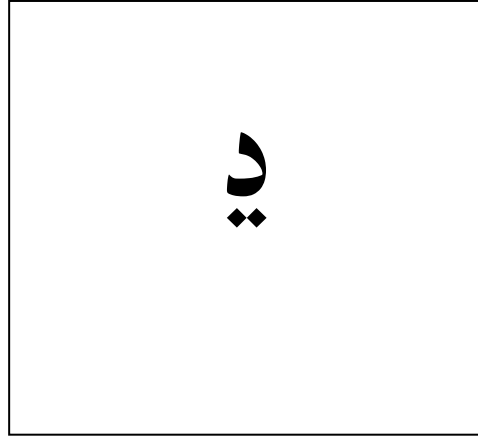
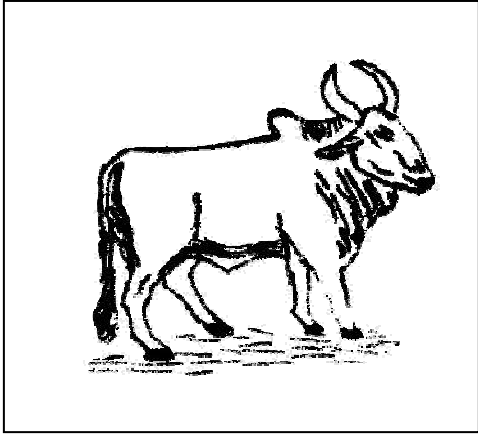

داگو

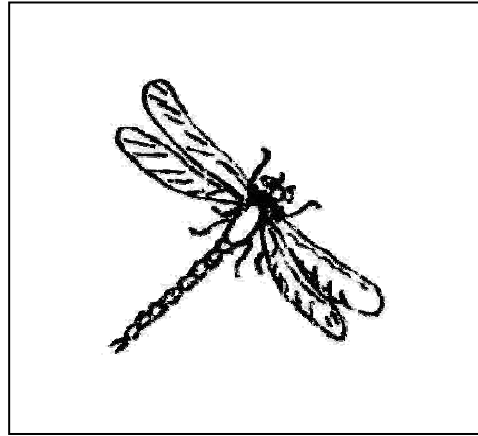
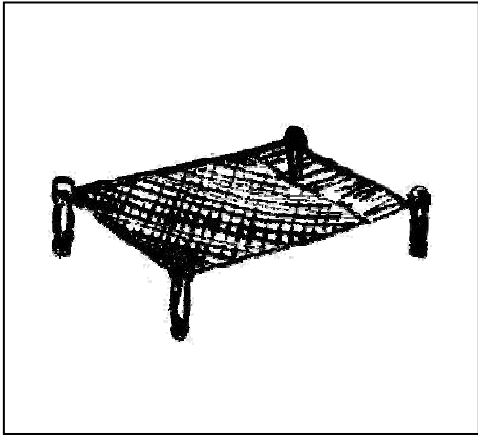

دوليو

دالوريو

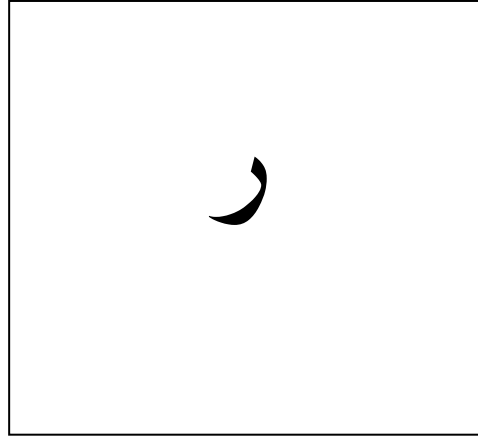
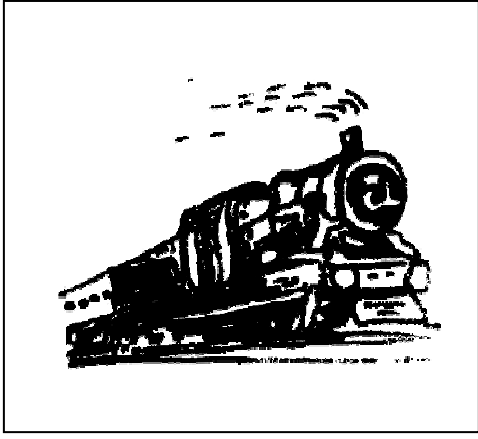

ريل گاڏي

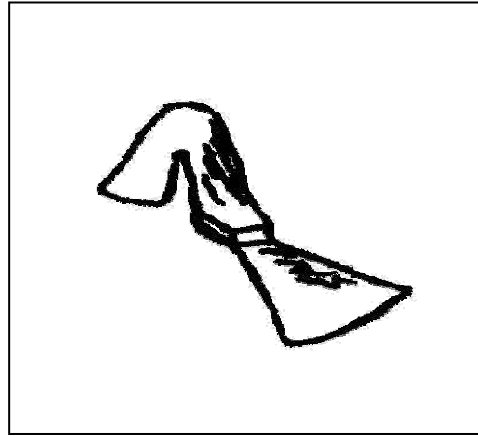
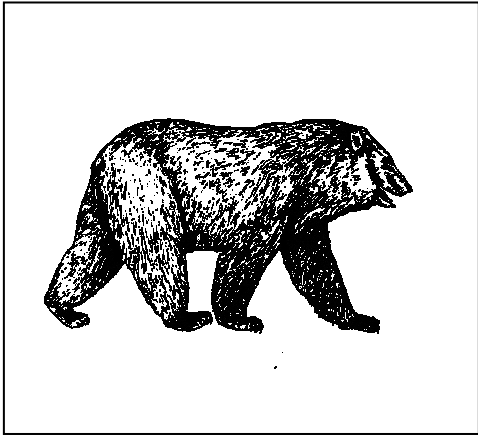

رينس

رني

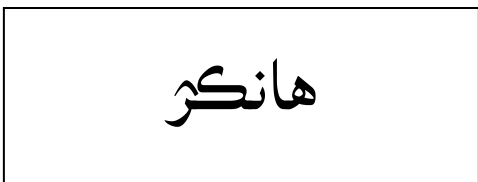
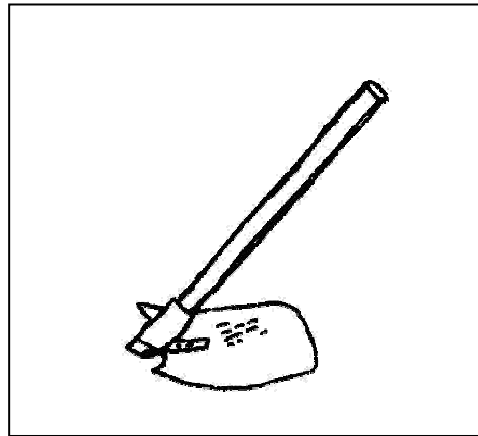
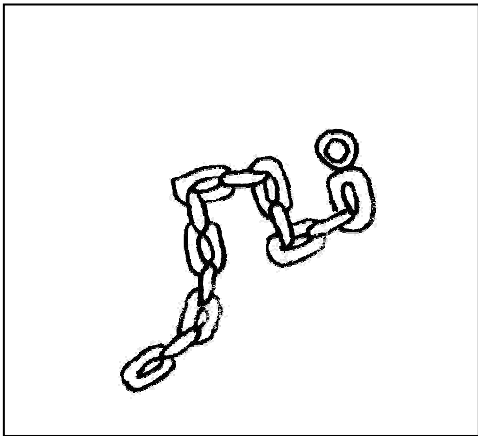
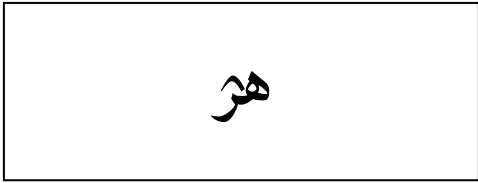
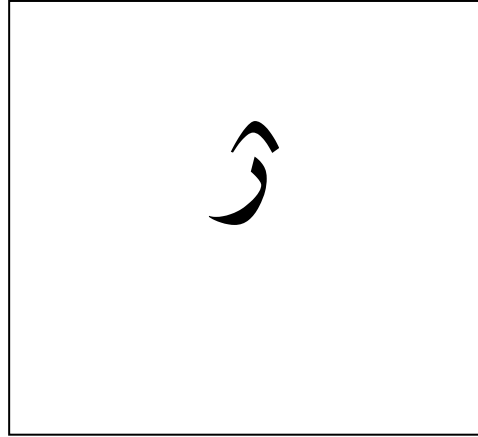
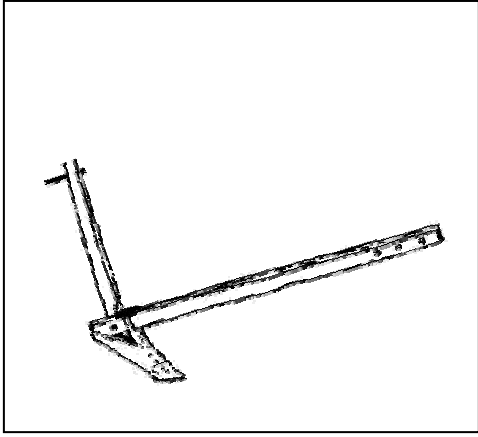

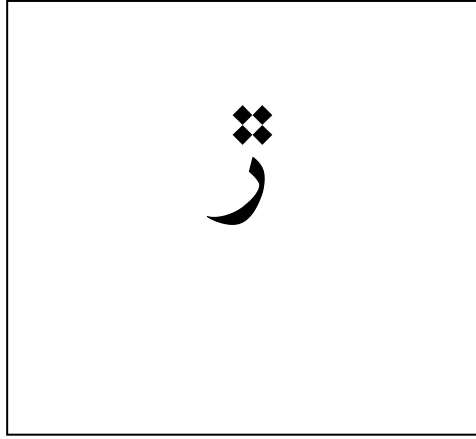
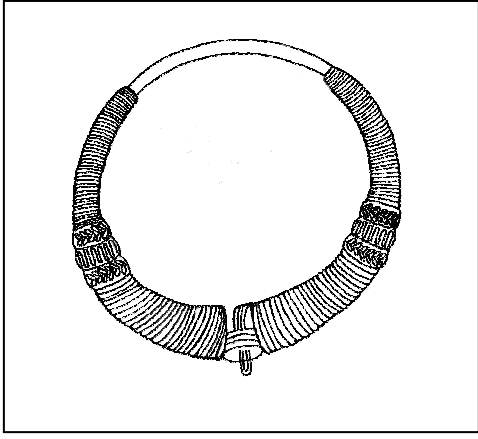

واژلو

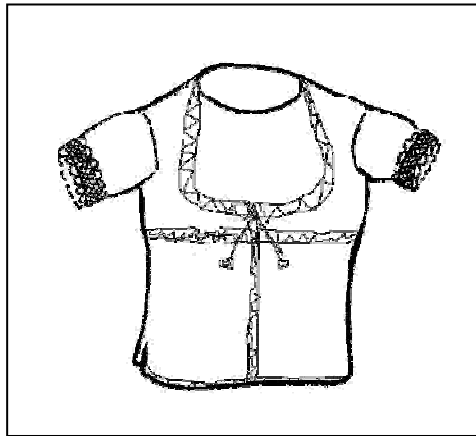
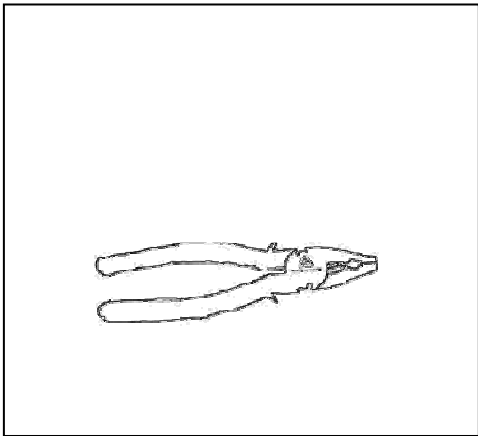

پَکڑ

زُولتِري

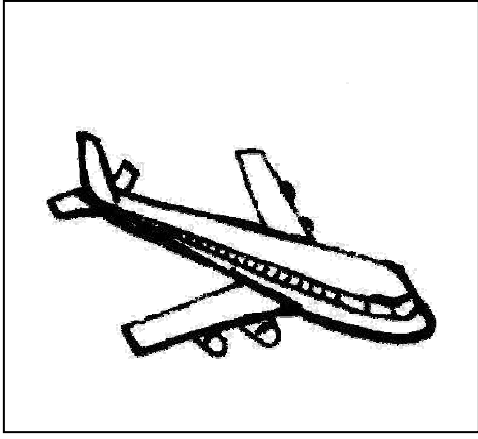

ز

زاز

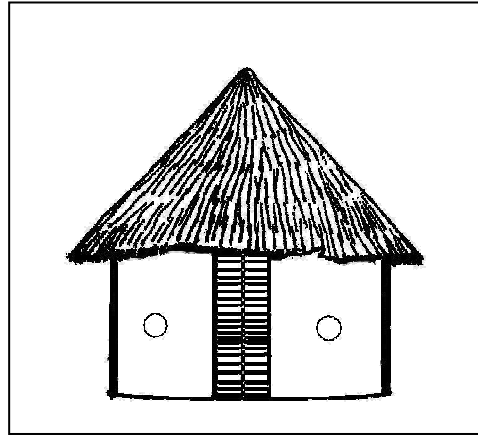
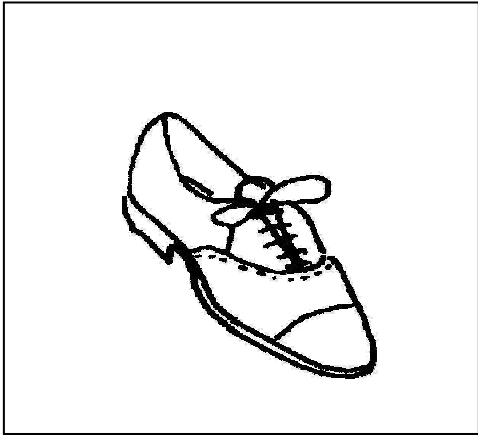

زوڙو

زُونپڙون

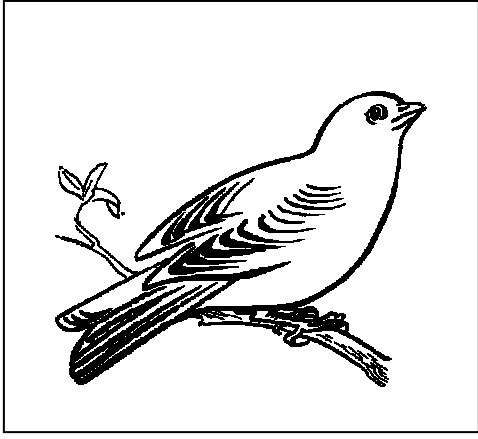

س

سكِلِي

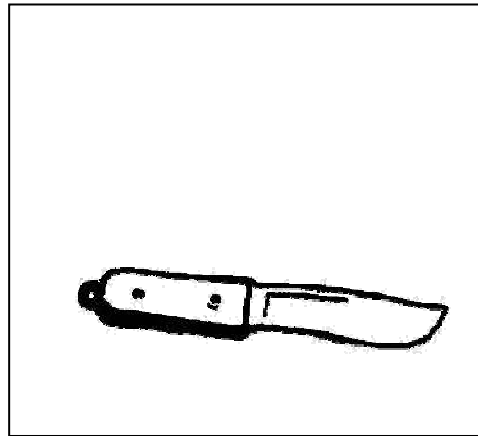
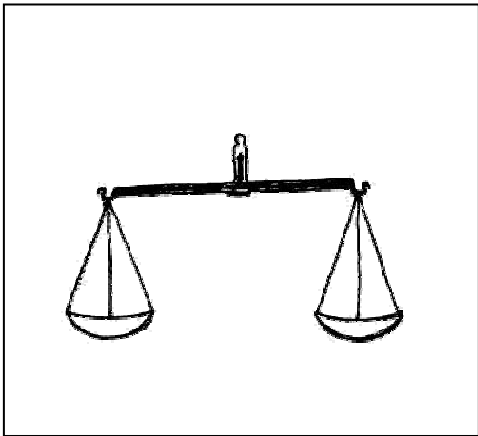

سائِمِي

سائِكُو

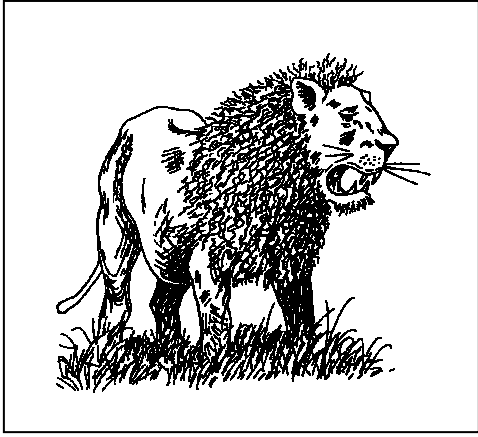

ش

شینهن

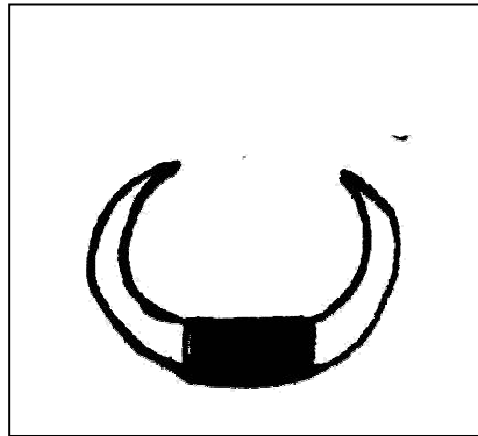
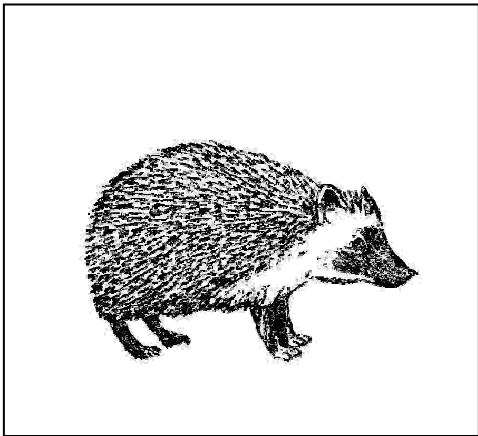

شیرو

شینگزان

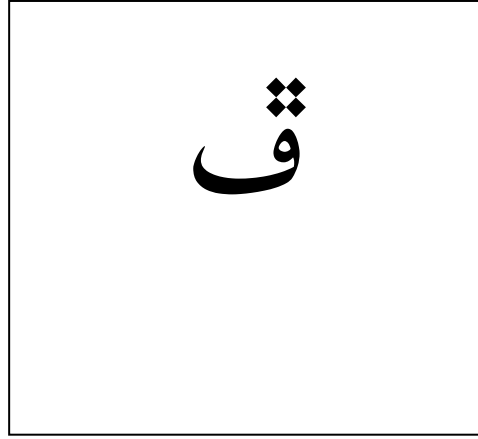
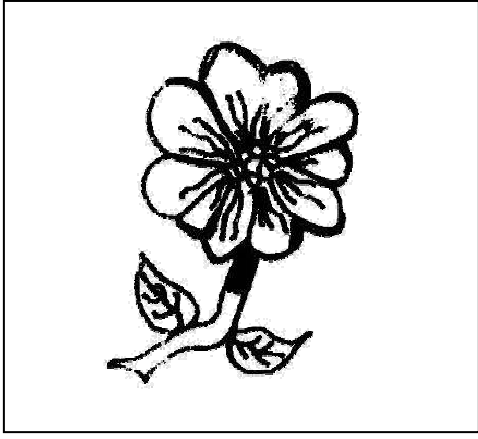

قُولْتُون

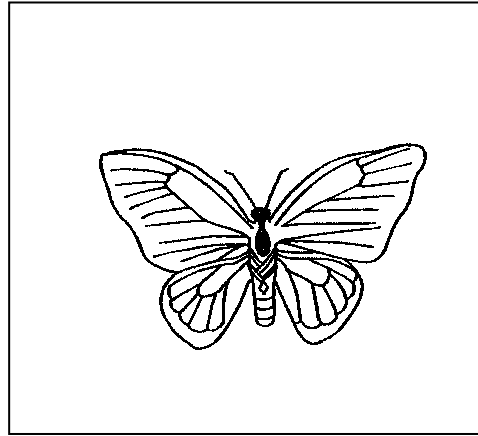
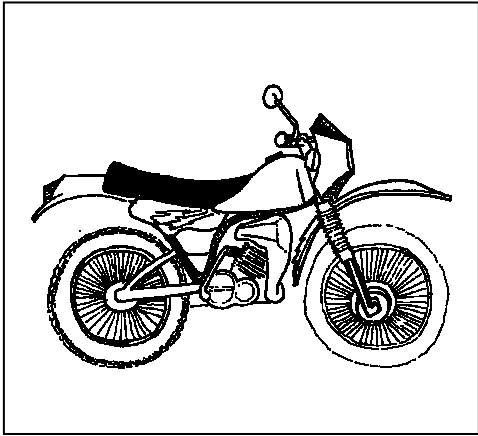

قَتَقْتِيُون

قُوْدِي

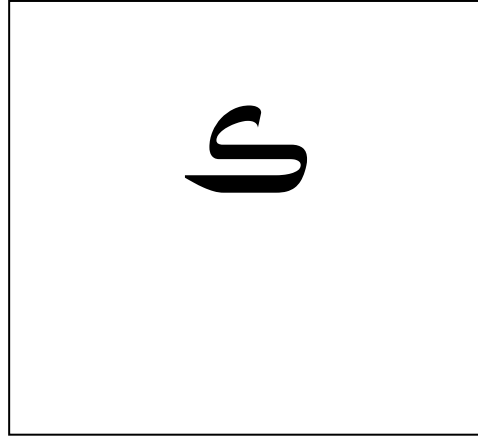
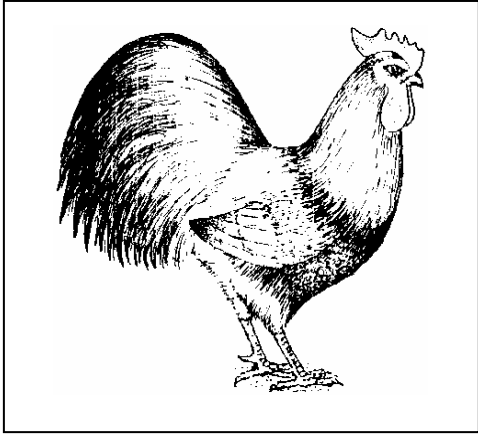

کُوکُرو

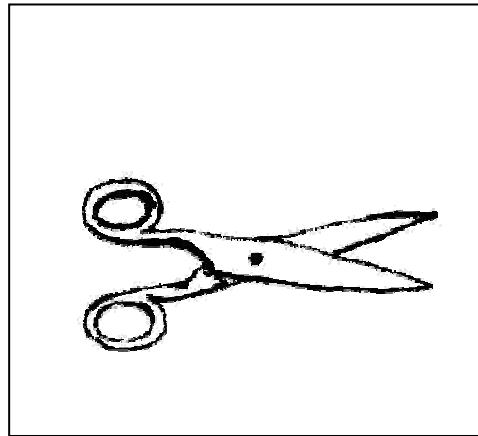
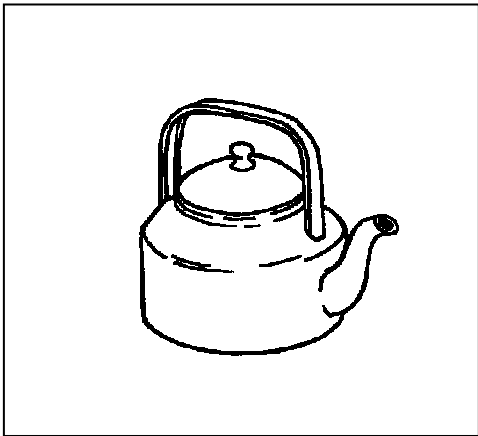

کِٹِی

کَاتِیْنِی

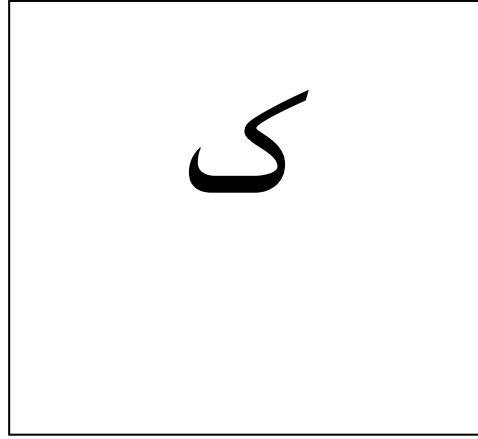
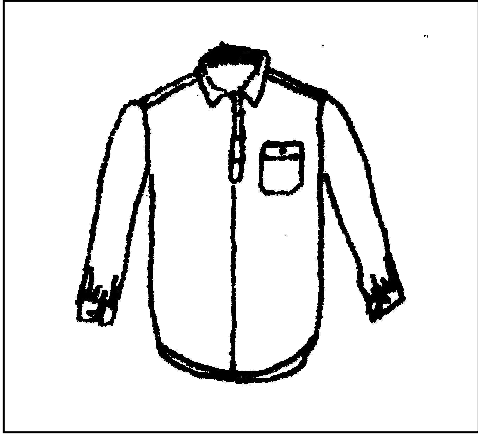

کَمِيش

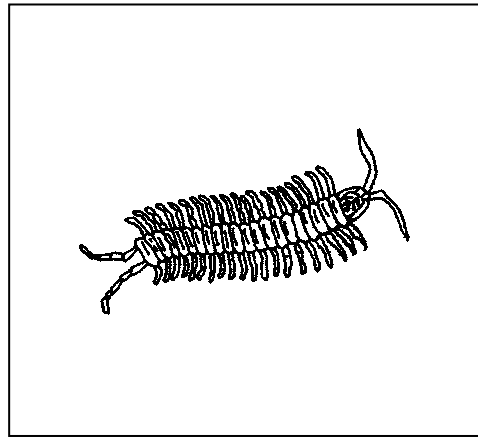
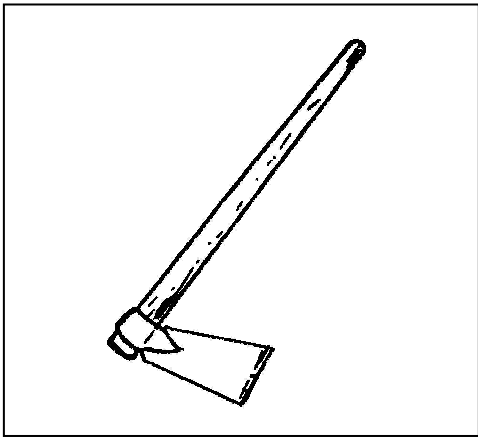

کئيترو

کانکُورو

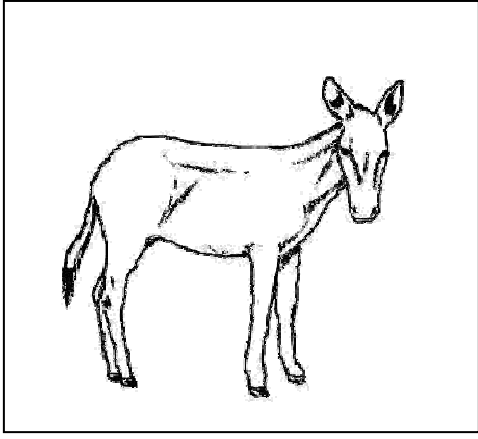

گ

گڈاڑون

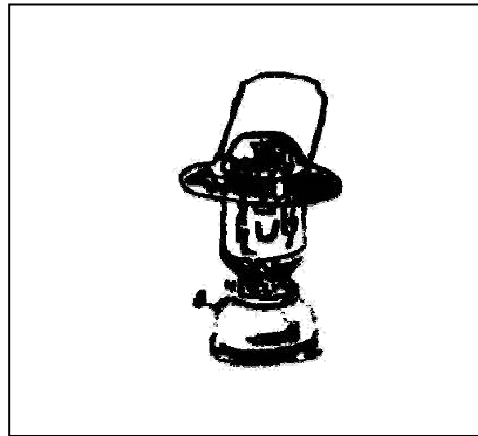
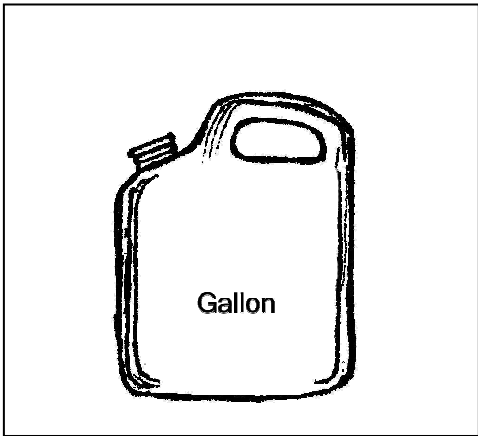

گیلن

گولو

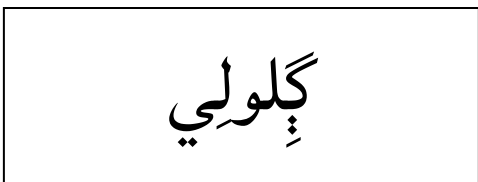
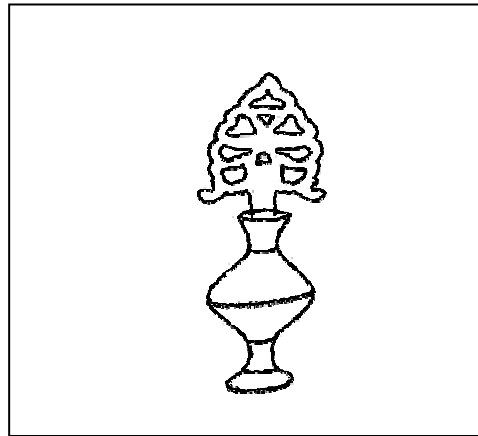
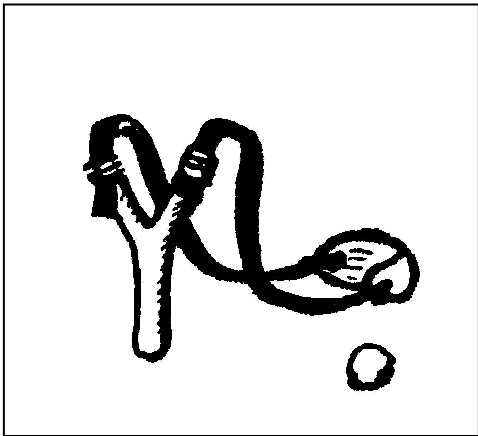
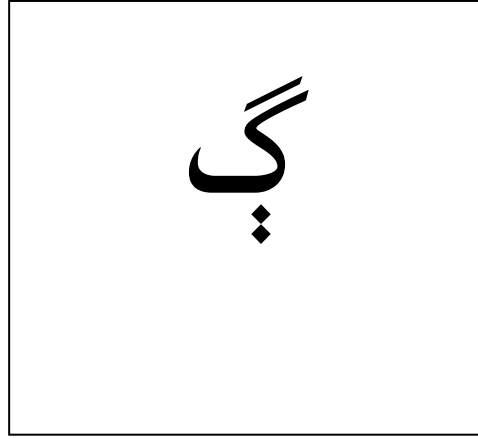
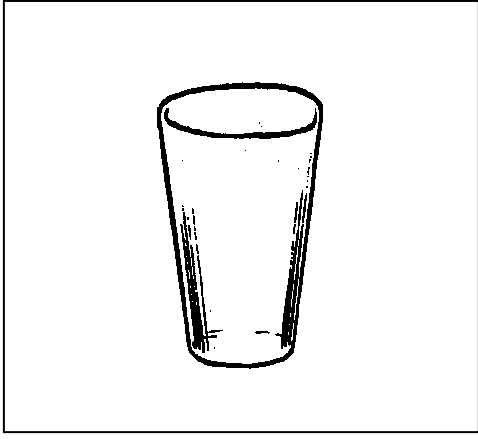

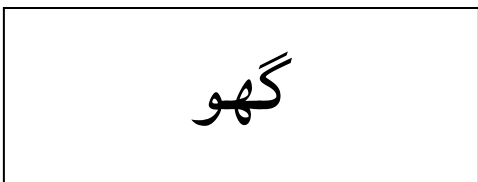
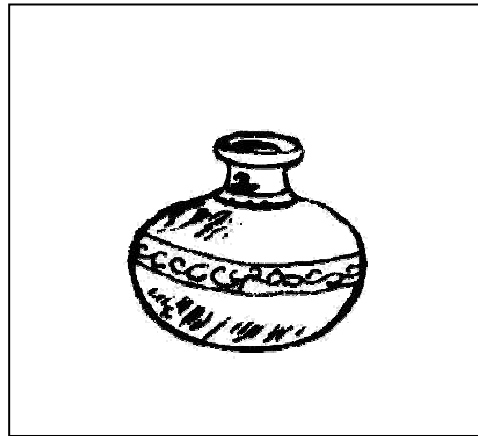
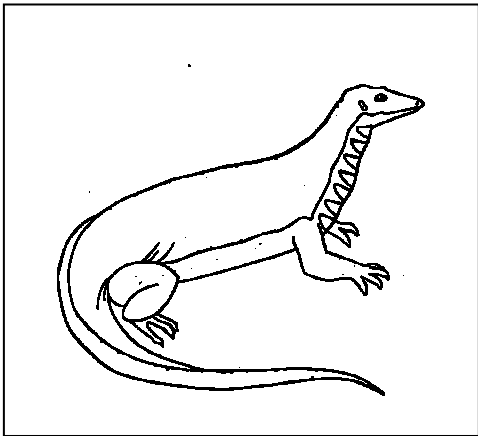
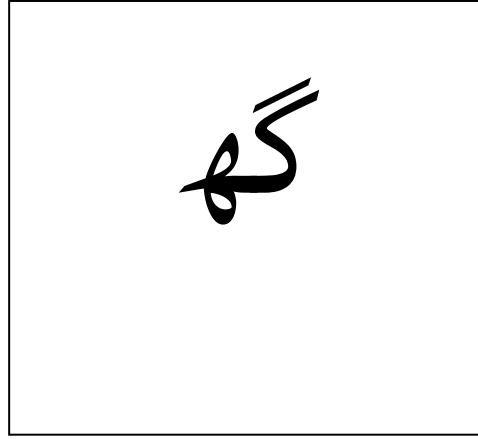
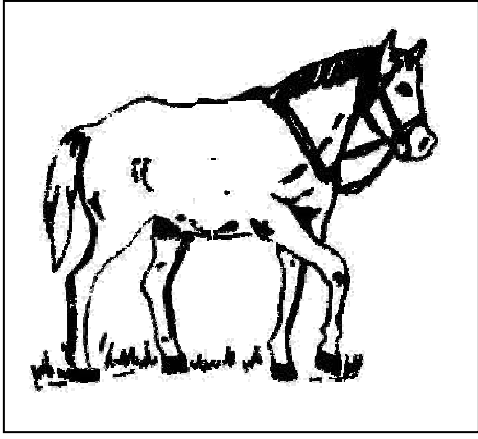

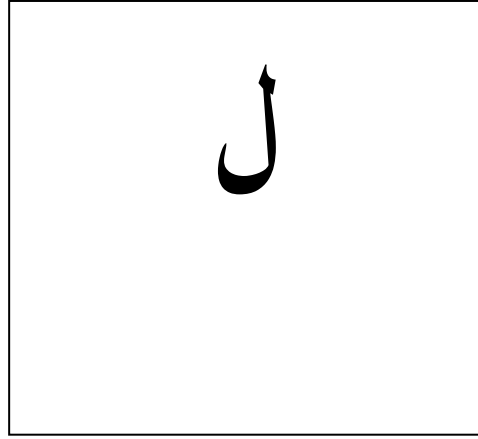
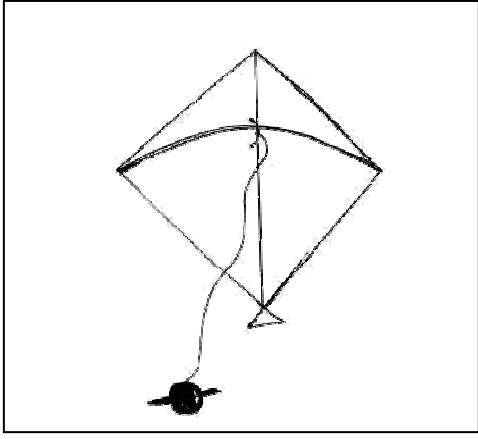

لگھڑ

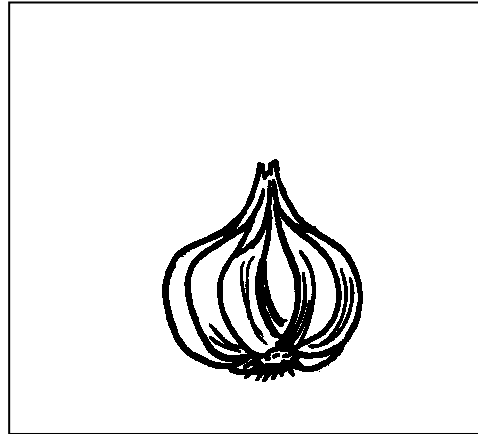

لاری

لانہٹ

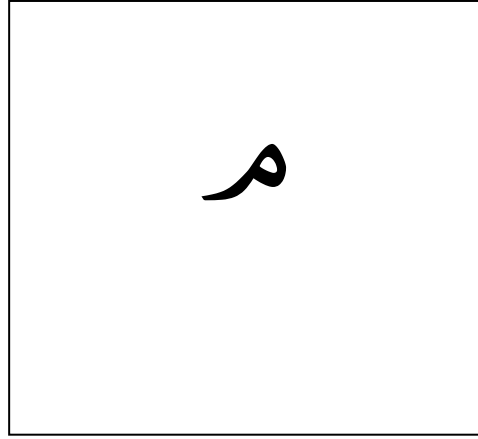
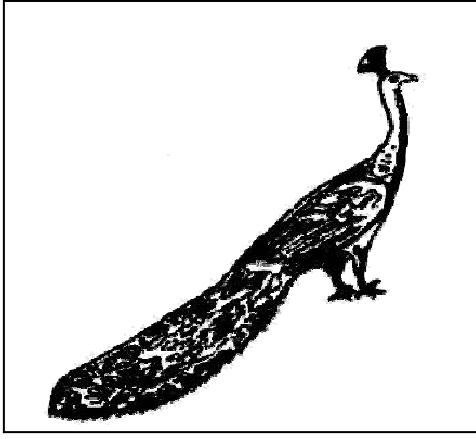

موريو

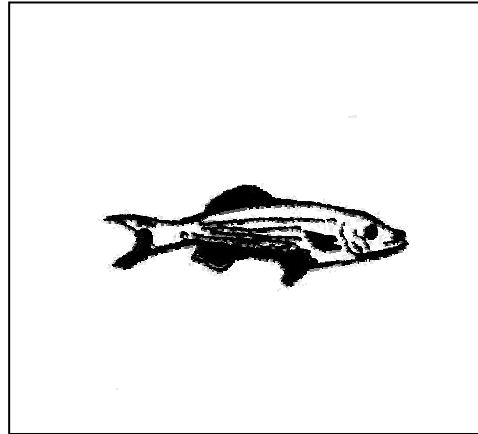
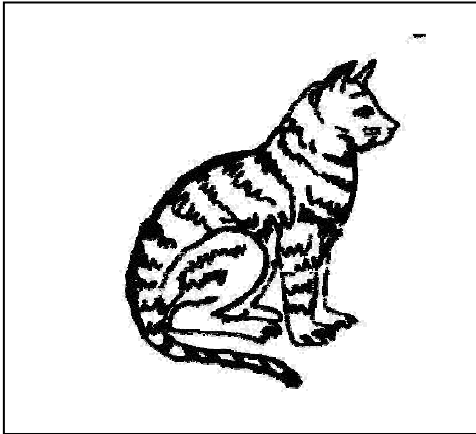

مناڙي

مسي

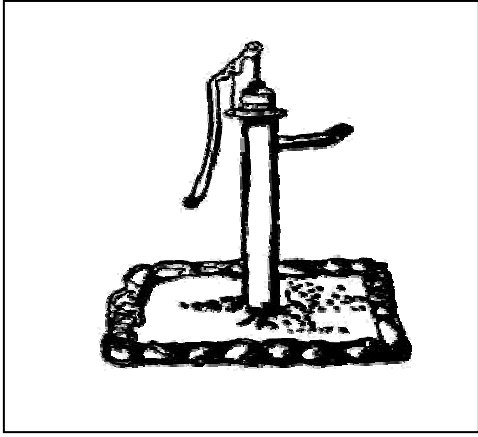

ن

نلکو

ن

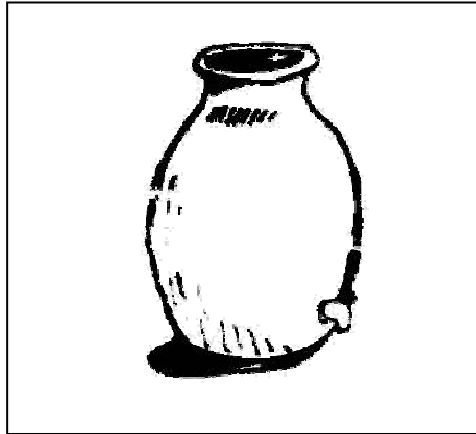

ناک

ناڌي

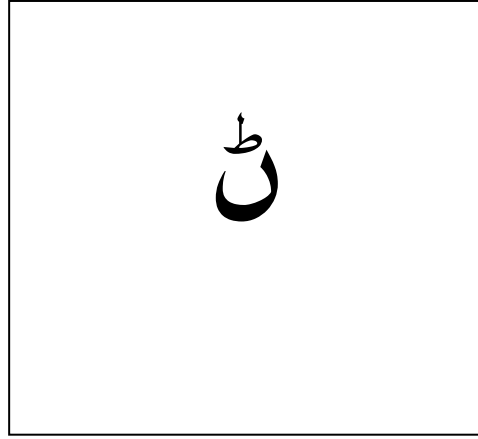
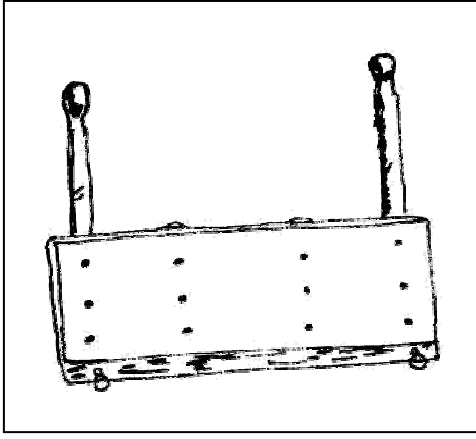

کینٹ

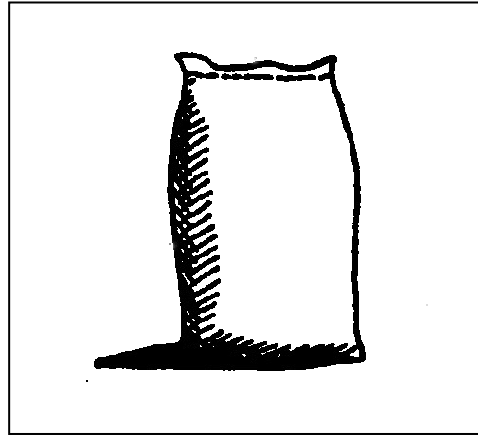
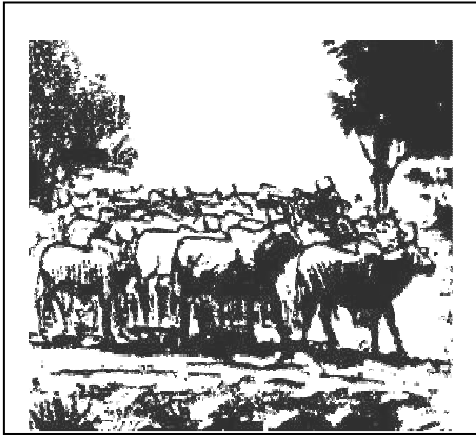

ڈن

گُونٹ

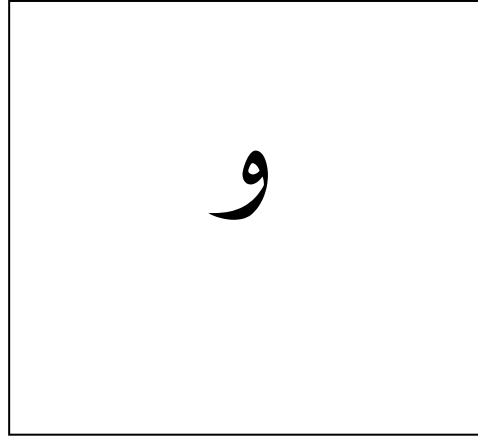
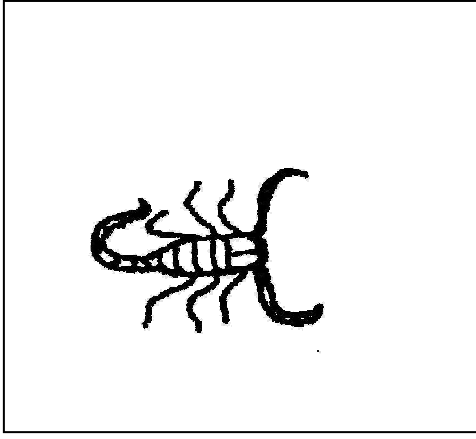

وینسو

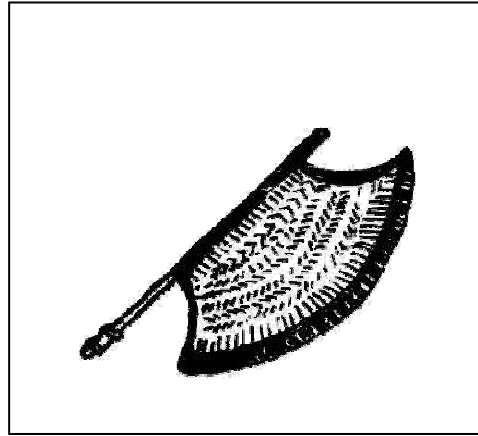
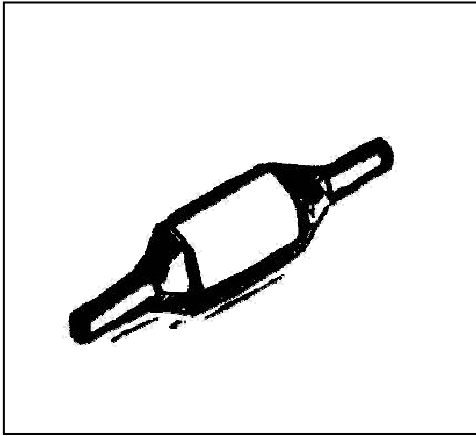

ویلٹ

وینزٹو

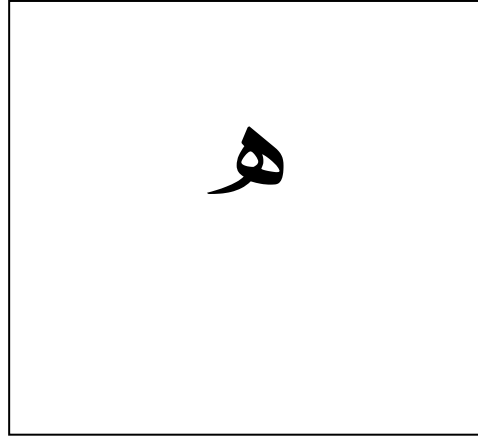
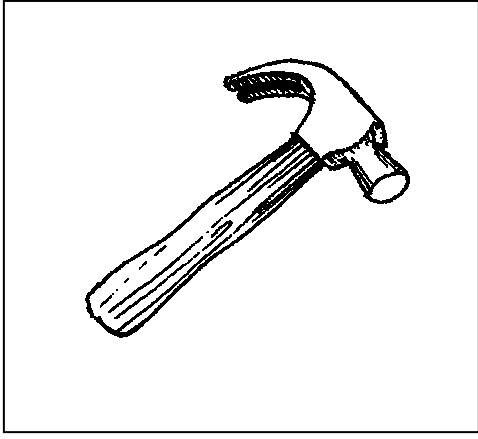

هتوڑی

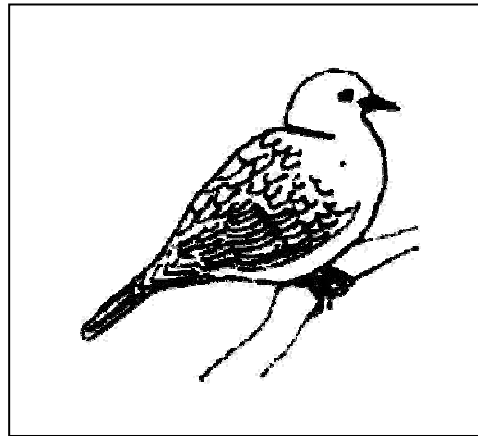
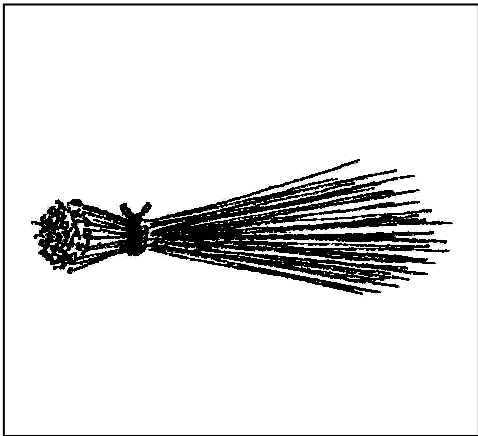

هاوینٹو

هولو

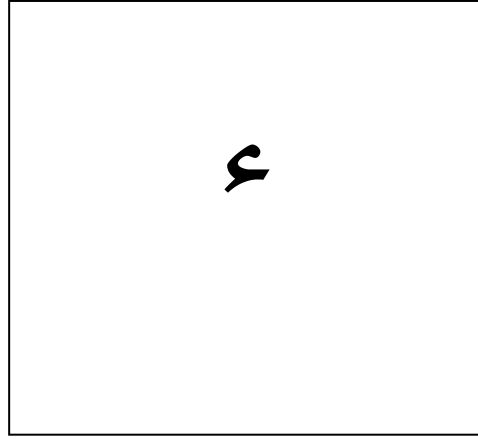
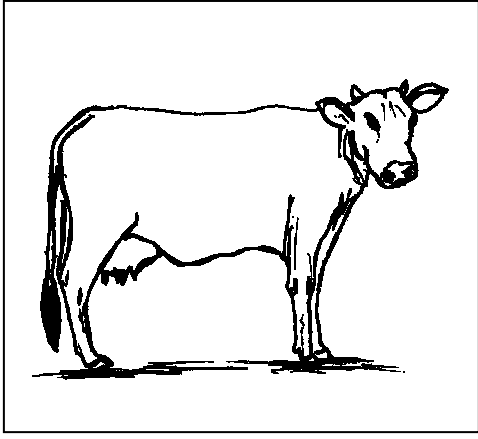

گائی

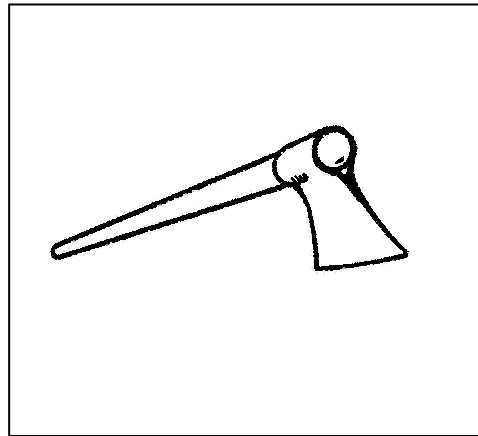
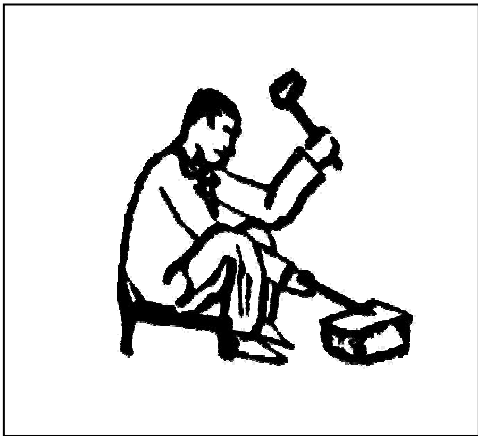

لوئار

کوئازو

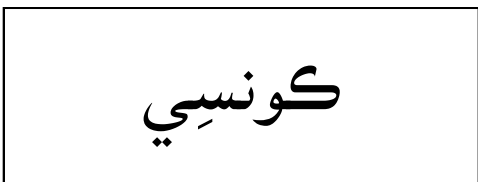
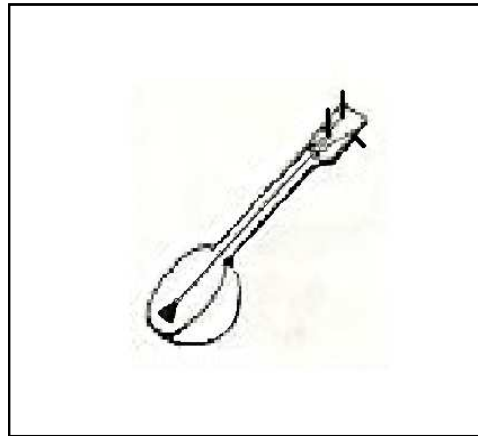
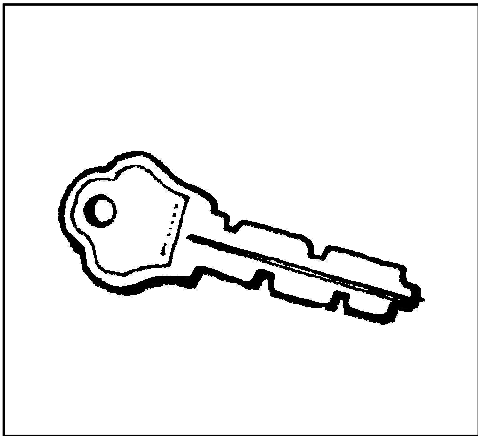
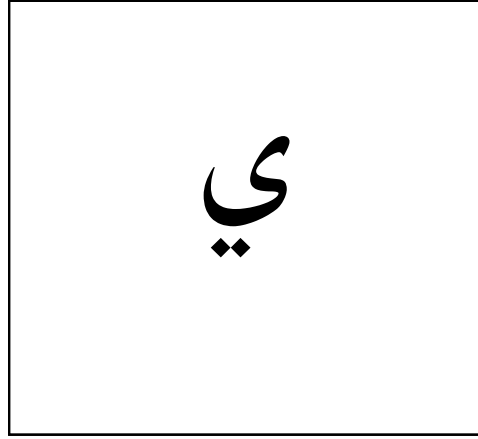
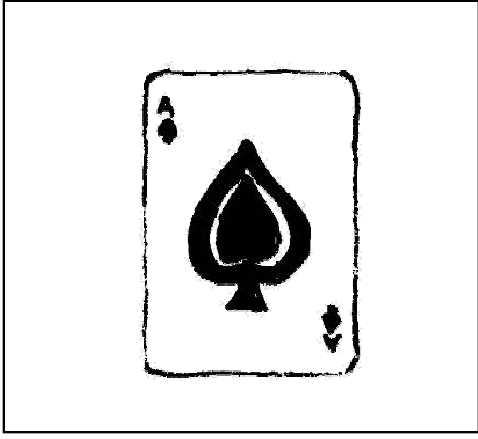

ٿراڌري ٻولي لڇا نا پارام ڪانڪ واٽون:

1) ٿراڌري ٻولي مان ٻي آواز سي زي سنڌي ٻولي مان نٿي.

تيمان آنا اکر ناهيا سي، ”ڙ“، ”ڙ“

زم:

1. ”ڙ“ ٿي ڌاتِيڙُون، ڌانت، ڏيوتا هان ڌاڙو.

2. ”ڙ“ ٿي ماڙو، واڙو، هاڙو ھان ۽ الوڙيو.

ٿراڌري ٻولي نا پارام ڪانڪ واتو:

2) سنڌي ٻولي مان پانس اکر سي زين نو آواز ٿراڌري ٻولي مان نٿي.

اي اکر آسي: خ، د، ڊ، غ، ف.

اي اکر رڳو نام مان لڪائي سي.

ٻيزو وار اي ٿراڌري ٻولي نا آواز پرمائي لڪائي سي.

زم:

خ ٿي ڪ ٿائي سي، زم تاريڪ، ڪيال، ڪُش، ڪُشبو، ڪٻير.

د ٿي ڌ ٿائي سي، زم ڌڪان، ڌرزي، وقاڌار.

ڊ ٿي ڍ ٿائي سي، زم ڌاڪتر، ڍيل.

غ ٿي ڳ ٿائي سي، زم ڳريب، ڳاڳ.

ف ٿي ڦ ٿائي سي، زم وقاڌار، ڦوت، آڦيسس،

3) سنڌي ٻولي مان ايڪ اکر سي ”ق“

زي ڪوڪ ٿائي سنڌي نا زم ٻولائي سي زم ”قوم“ هان ڪوڪ ٿائي ”ڪ“ نو آواز ٺهري سي، زم ”ٻنڌوڪ“، ”وڪت“.

4) سنڌي ٻولي مان الاهي ٻيزا اکر سي، زي لڇا مان ڦرڻ هونئي سي، ٻن ٻوليا مان ڪانئين ڦرڻ نٿي هونو، زم: ت ني جڳائي ط، ح ني جڳائي ه زي ني

جڳائي ڌ، ض هان ڌ، ٿ هان ص ني جڳائي س، ع ني جڳائي ا، هان. گ ني جڳائي ڳ ٿي ٿائي سي.

زو ٻوليان مان سنڌي هان ٿراڌري ٻولي مان ڪانئي ڦرڻ نٿي تو لفظ سنڌي نا زم لڪائي سي.

زم:

ضرورت، حيران، طاقت، قرض، مثال هان عمر.

زو رڳو ڪانڪ نُڪتان نو ڦرڻ سي توڻي ايم لڪائي سي زم: صاڻ، ڦينصلو، ڦرڻ.

زو لفظ نو ٻيزو پانڳو الاهي ڦرڻ هونئي سي تو زم ٻولائي سي ايم لڪائي سي.

زم: ڪت (خط)، ڪلت (غلط)، هان ڪاس (خاص)



ٲراڊري ٲولي وانسيام آڪتاب

ٲماري الاهي مڌه ڪرشي

لچاوازا:

ميرخان هان هيمني

قوٽو ناهياوازا:

ميرخان، هيمني هان ايسر داس

ڪمپيوٽر لي آٽوٲ:

ميرخان ٲجي

مڌه ڪريا وازا:

ماسٽر مانو، ماسٽر ٲريم ساگر، ماسٽر ٲگوانداس هان ماسٽر لڪو



چاپيا وازا: ٲراڊري ناٲ سڌار منڌلي

ٲي او باڪس 66 ميرٲورخاص 69000

قيمت

چاپو نمٲر

چاپيا ني تاريخ

50 روٲيا

ٲهري ڌقا: 100

2016